

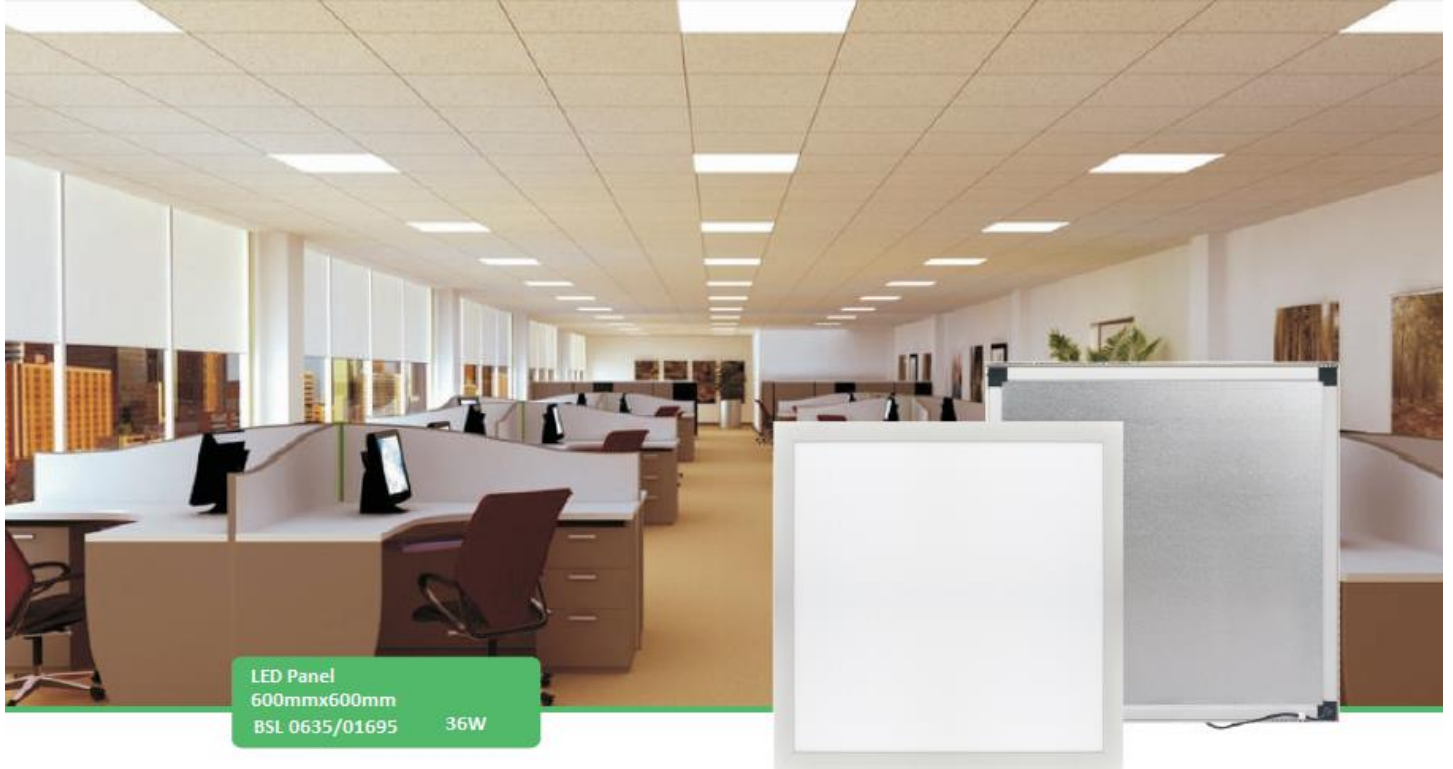

**BIGSOLAR**

Λ. Νάτο 100, 19300 Ασπρόπυργος  
**Τηλ:** 210 5509090  
**Φαξ:** 210 5594559  
**E-mail:** [info@bigSolar.gr](mailto:info@bigSolar.gr)  
**Web:** [www.bigSolar.gr](http://www.bigSolar.gr)



### Photos of Product



### Accessories



Driver holder  
(Optional accessory)



Safety cable  
(Included accessory)



Recessed spring kit  
(Optional accessory)



Surface mounted kit  
(Optional accessory)



Gypsum board frame  
(Optional accessory)

### Technical Specifications

<b>Model Code</b>	BSL 0635/01695
<b>Wattage</b>	36W
<b>Lumens</b>	3240 Lm
<b>Efficiency</b>	>90 Lm/W
<b>LED Brand Chip</b>	SMD 2835
<b>CRI (Ra)</b>	>80 Ra
<b>UGR</b>	<19
<b>CCT</b>	4000K
<b>Beam Angle</b>	110 Degree
<b>Working Voltage</b>	230V AC ±10%
<b>IP Rating</b>	IP20
<b>Lifetime (Lm80 Test Report)</b>	>50.000h
<b>Power Factor</b>	>0.9
<b>Overvoltage Protection</b>	2KV
<b>Working Temperature</b>	-20°C - +45°C
<b>Class</b>	I
<b>Weight</b>	2.8 Kg
<b>Flickering Free</b>	< 5%
<b>Warranty</b>	5 Years
<b>Color</b>	White
<b>Dimensions</b>	595x595X12,5mm

### Dimensions

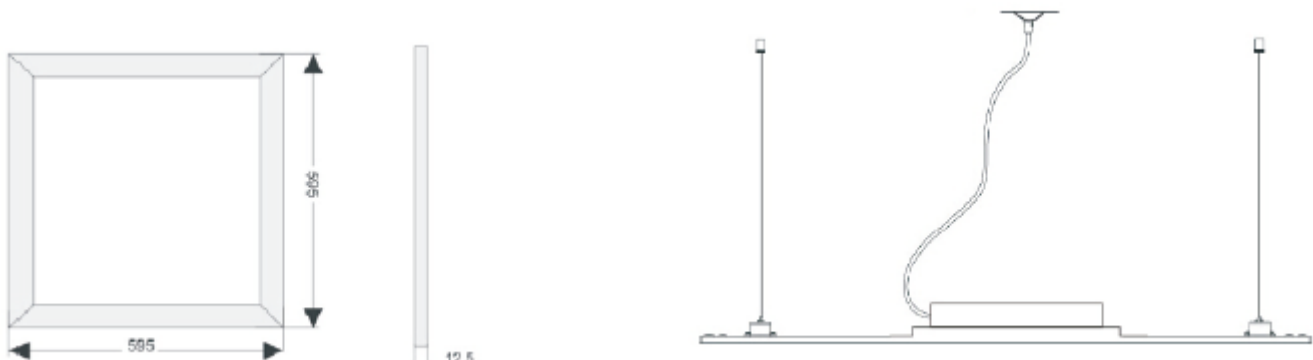

### Connection Mode

*\*Non Dimmable Version*

*\*Dimmable Version 1-10*

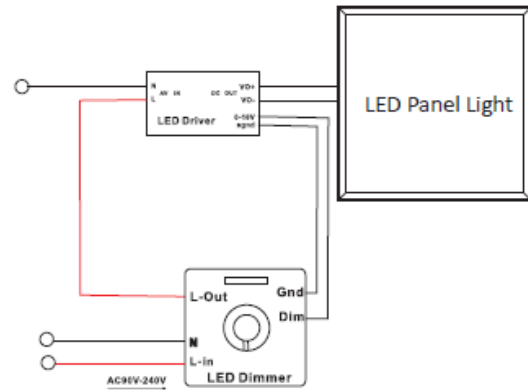
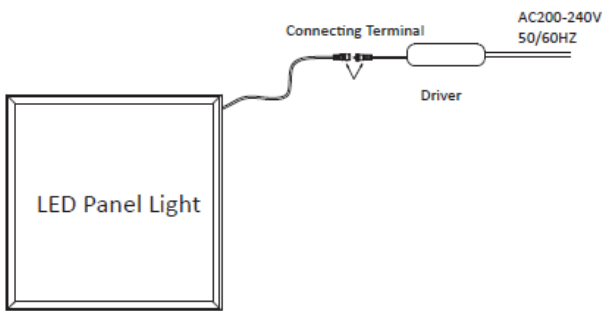

### Quick Connector

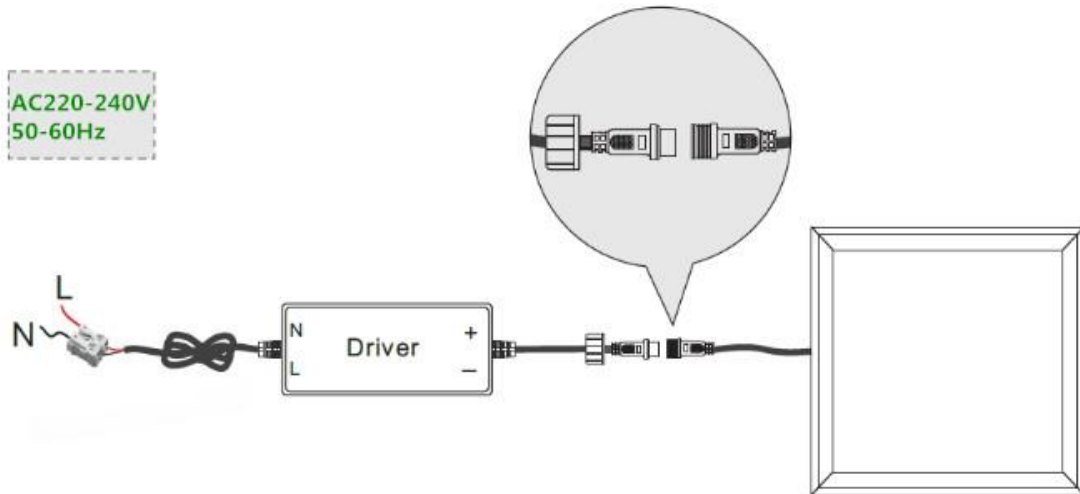

### Light Distribution Curve

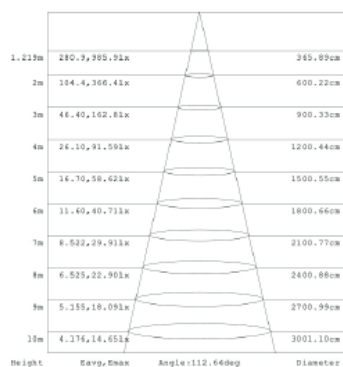



**BIGSOLAR**

Λ. Νάτο 100, 19300 Ασπρόπυργος  
Τηλ: 210 5509090  
Fax: 210 5594559  
E-mail: [info@bigsolar.gr](mailto:info@bigsolar.gr)  
Web: [www.bigsolar.gr](http://www.bigsolar.gr)

### User Manual

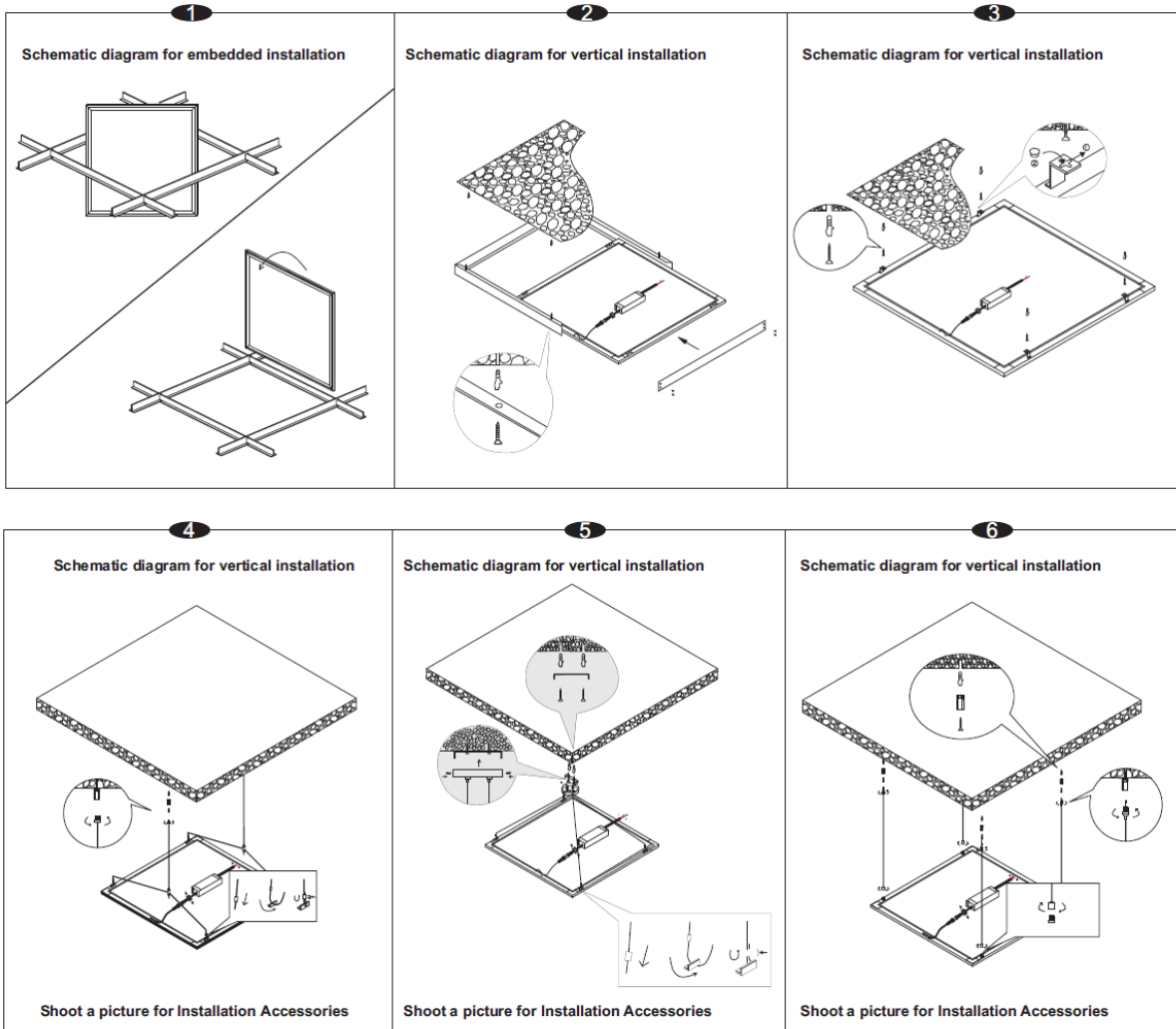

### Installation Induction

