



**BIGSOLAR**

Λ. Νάτο 100, 19300 Ασπρόπυργος

**Τηλ:** 210 5509090

**Fax:** 210 5594559

**E-mail:** [info@big solar.gr](mailto:info@big solar.gr)

**Web:** [www.big solar.gr](http://www.big solar.gr)

## Floodlight Modular 1000W - T



### Technical Characteristics

<b>Light Source</b>	SMD 3535
<b>Control Gear</b>	NFS-1K2D210BC
<b>Input Voltage Range</b>	198-457Vac 50/60Hz
<b>LED Power</b>	909-972 W
<b>System Power</b>	963-1013 W
<b>Luminous Flux</b>	139.800-144.800 lm
<b>Power Factor</b>	>0.95
<b>CCT</b>	3000/4000/5700 K
<b>CRI</b>	>70 / >80
<b>Beam Angle</b>	12°/30°/60° symmetric; 40°x15°/60°x15° /100°x17°/100°x60°/130°x25° asymmetric
<b>THD (230VAC)</b>	<20%
<b>Surge Protection</b>	20KV
<b>Dimmable</b>	Dali-2; DMX
<b>Housing Color</b>	Black / Gray
<b>IP Class</b>	IP66
<b>Working Temperature</b>	-20 to +40 °C
<b>Working Humidity</b>	10-90 RH%
<b>Power Cable</b>	1m H07RN-F 3x1.5



ΦΩΤΙΣΜΟΣ BIGLED



ΦΩΤΟΒΟΛΤΑΪΚΑ



ΨΥΞΗ-ΘΕΡΜΑΝΣΗ



ΒΙΟΜΑΖΑ-ΒΙΟΑΕΡΙΟ



**BIGSOLAR**

Λ. Νάτο 100, 19300 Ασπρόπυργος

**Τηλ:** 210 5509090

**Fax:** 210 5594559

**E-mail:** [info@big solar.gr](mailto:info@big solar.gr)

**Web:** [www.big solar.gr](http://www.big solar.gr)

### Product details

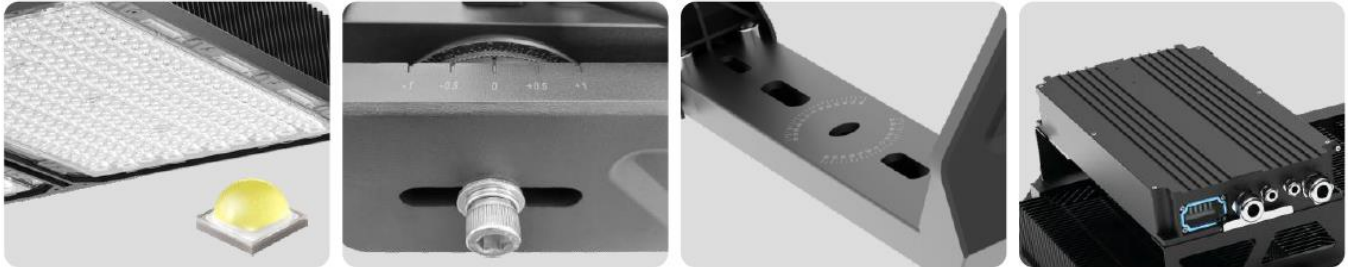

### Dimensions

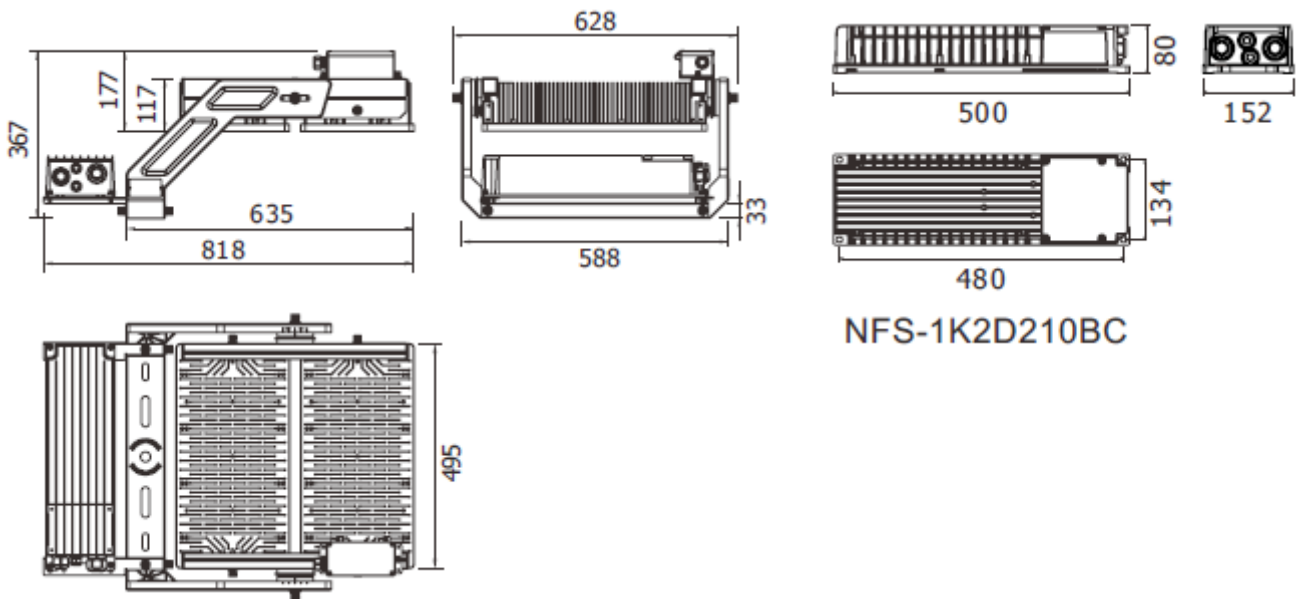

ΦΩΤΙΣΜΟΣ BIGLED



ΦΩΤΟΒΟΛΤΑΪΚΑ



ΨΥΞΗ-ΘΕΡΜΑΝΣΗ



ΒΙΟΜΑΖΑ-ΒΙΟΑΕΡΙΟ

**Luminous intensity distribution diagram**

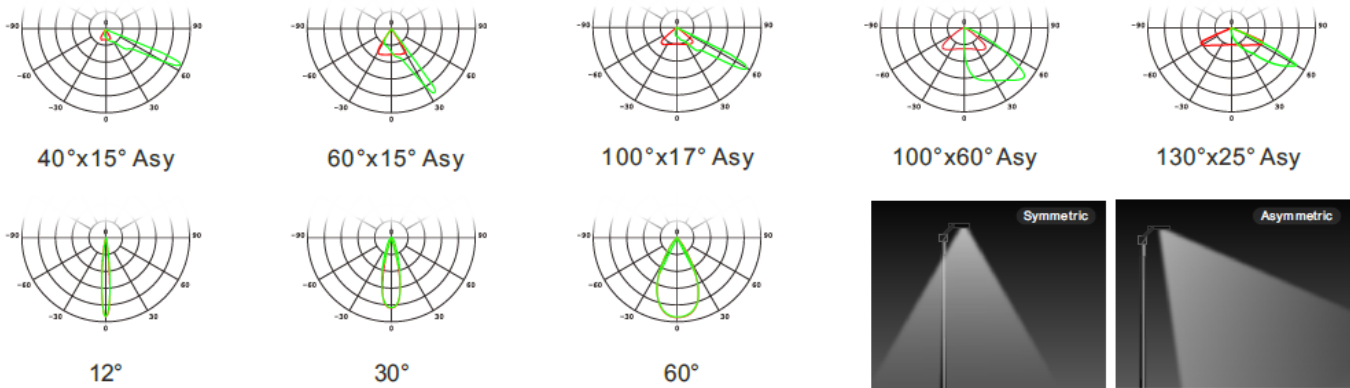

**Installation**



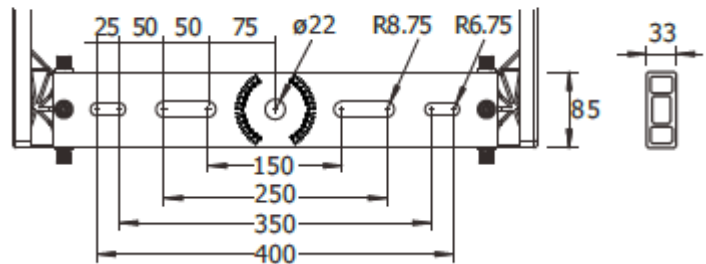

**Mounting bracket**

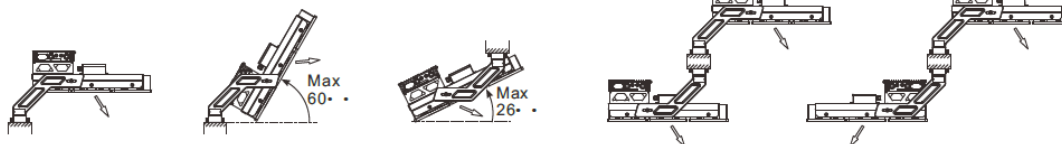

**Position allowed** 

This Modular floodlight can be installed on pole, wall, ceiling or on a horizontal surface.



**Position not allowed** 

**Note:** Considering the heat dissipation, load bearing and dust accumulation, some installation methods are not allowed.

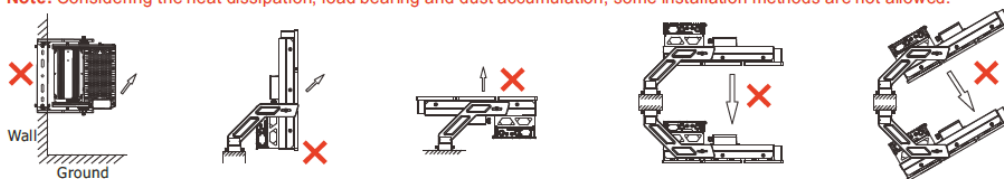

ΦΩΤΙΣΜΟΣ BIGLED



ΦΩΤΟΒΟΛΤΑΪΚΑ



ΨΥΞΗ-ΘΕΡΜΑΝΣΗ



ΒΙΟΜΑΖΑ-ΒΙΟΑΕΡΙΟ



**BIGSOLAR**

Λ. Νάτο 100, 19300 Ασπρόπυργος

**Τηλ:** 210 5509090

**Fax:** 210 5594559

**E-mail:** [info@big solar.gr](mailto:info@big solar.gr)

**Web:** [www.big solar.gr](http://www.big solar.gr)

### Effective Projected Area (EPA=SCx)

Unit: m<sup>2</sup>



Power	Tilt angle	0°	10°	20°	30°	45°	60°
1000W		0.08	0.09	0.10	0.13	0.15	0.18

### Application

Suitable for football stadiums, tennis courts, stadiums and other large sports venues, high mast, harbor, airport, warehouse, workshop, gas stations, toll stations, parking area, etc.



ΦΩΤΙΣΜΟΣ BIGLED



ΦΩΤΟΒΟΛΤΑΪΚΑ



ΨΥΞΗ-ΘΕΡΜΑΝΣΗ



ΒΙΟΜΑΖΑ-ΒΙΟΑΕΡΙΟ