



Technical Specifications

Model Code	0636/03963
Wattage	8W
Lumens	960Lm
Efficiency	120Lm/W
LED Brand Chip	LUMILEDS 2835R
CRI (Ra)	>80 Ra
LED Chip Quantity	80Pcs
CCT	3000K-4000K-5000K
Beam Angle	360 Degree
Working Voltage	100 – 250V AC – 50/60Hz
IP Rating	IP65
Lifetime	>54.000h
Power Factor	>0.9
Working Temperature	-20°C - +65°C
Base	E27
Material	Aluminum and PC
Dimensions	Φ70mmxL190mm
Warranty	5 Years



**High
Brightness**



Longlife



Security



**Energy
Saving**



**Protect
Your Eyes**



**Low-carbon
Green**



**No
Flicker Free**



**No
Radiation**

General Specifications

**Waterproof
IP65**



Rubycon capacitor



**120Lm/W
SMD2835**



Long Lifespan of 10years



Reliability Test

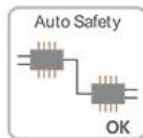

Safety Protection Circuit



No Mercury
No UVLight



Big Saving(87%)
on Electricity Costs

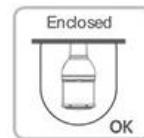

Usable in Enclosed
Luminaires



Omni Wide Angle

Installation Diagram

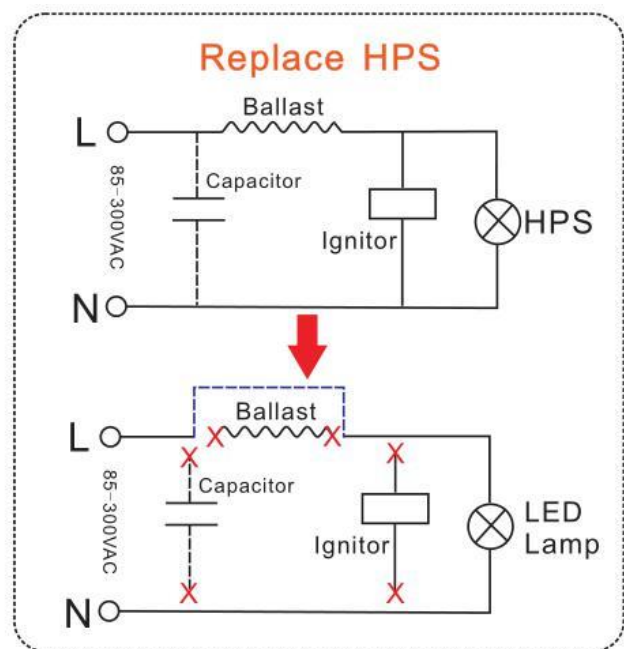
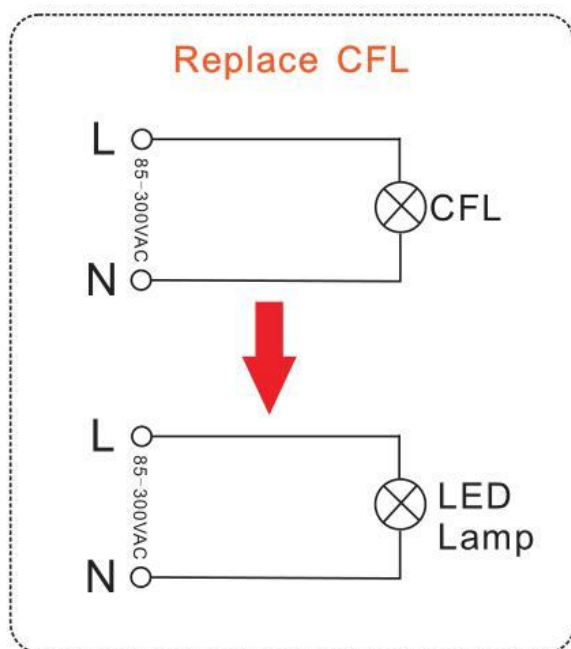

High
Brightness



Longlife



Security



Energy
Saving



Protect
Your Eyes



Low-carbon
Green



No
Flicker Free



No
Radiation

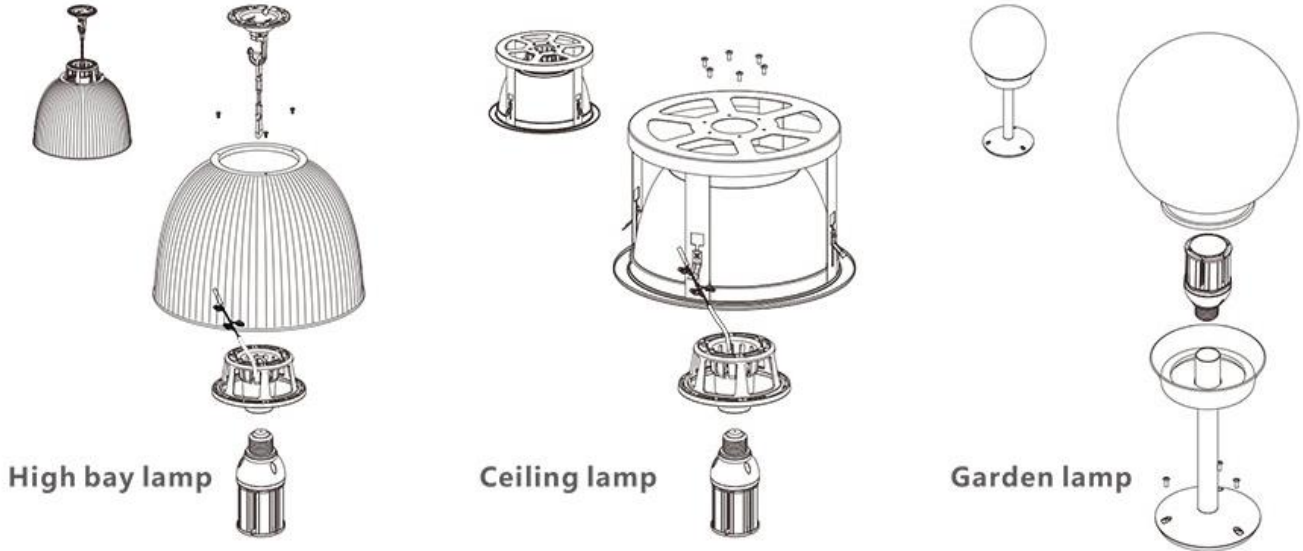

Projects



Certificates

