



BIGSOLAR

Λ. Νάτο 100, 19300 Ασπρόπυργος

Τηλ: 210 5509090

Fax: 210 5594559

E-mail: info@big solar.gr

Web: www.big solar.gr

Floodlight Modular 1000W - S



Technical Characteristics

Light Source	SMD 3535
Control Gear	Matrix/Mono-S/Mono-H
Input Voltage Range *	100-305Vac; 249-528Vac; 180-528Vac 50/60Hz
LED Power	909-972 W
System Power	963-1013 W
Luminous Flux	139.800-144.800 lm
Power Factor	>0.95
CCT	3000/4000/5700 K
CRI	>70 / >80
Beam Angle	12°/30°/60° symmetric; 40°x15°/60°x15° /100°x17°/100°x60°/130°x25° asymmetric
THD (230VAC)	<20%
Surge Protection	20KV
Dimmable	0/10V; Dali-2; DMX
Housing Color	Black / Gray
IP Class	IP66
Working Temperature	-20 to +40 °C
Working Humidity	10-90 RH%
Power Cable	1m H07RN-F 3x1.5

*Certified voltage range: Matrix(110-277Vac); Mono-S(100-240Vac); Mono-H(277-480Vac)



ΦΩΤΙΣΜΟΣ BIGLED



ΦΩΤΟΒΟΛΤΑΪΚΑ



ΨΥΞΗ-ΘΕΡΜΑΝΣΗ



ΒΙΟΜΑΖΑ-ΒΙΟΑΕΡΙΟ



BIGSOLAR

Λ. Νάτο 100, 19300 Ασπρόπυργος

Τηλ: 210 5509090

Fax: 210 5594559

E-mail: info@bigsolar.gr

Web: www.bigsolar.gr

Product details

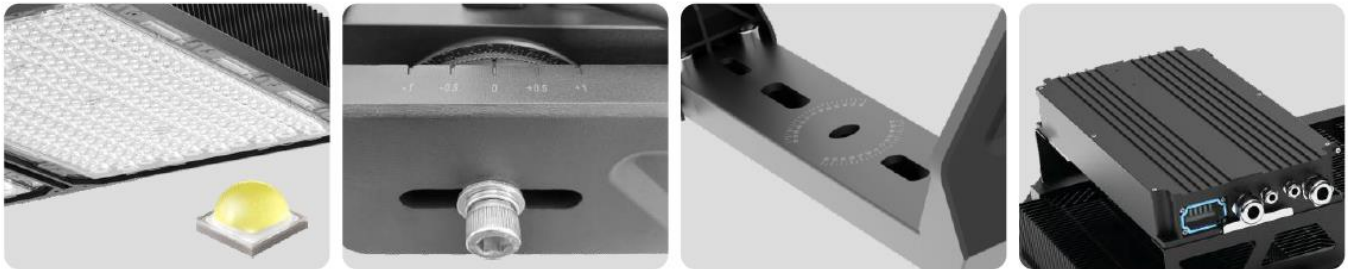

Dimensions

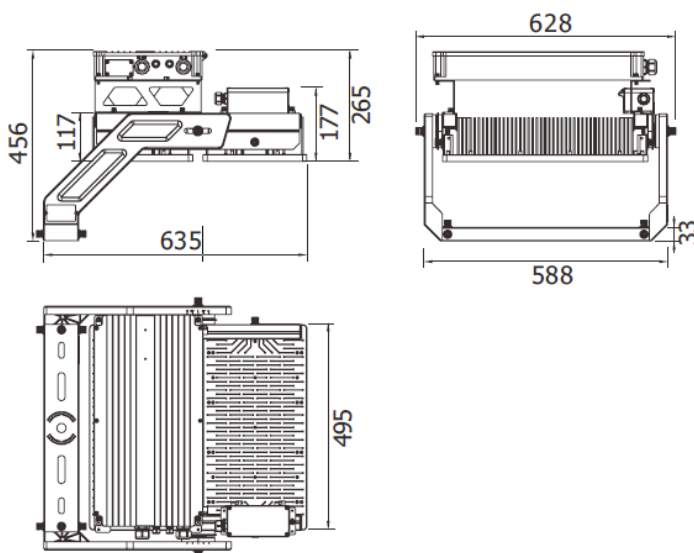

Control Gear (Driver Box)

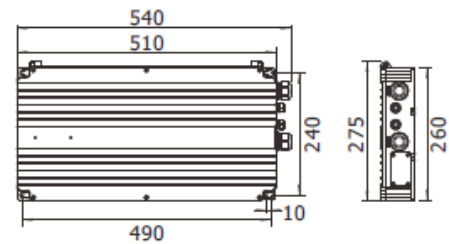

Matrix-340-1000W

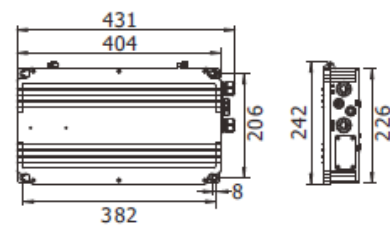

Mono-340-1000W-S/H

Luminous intensity distribution diagram



ΦΩΤΙΣΜΟΣ BIGLED



ΦΩΤΟΒΟΛΤΑΪΚΑ



ΨΥΞΗ-ΘΕΡΜΑΝΣΗ



ΒΙΟΜΑΖΑ-ΒΙΟΑΕΡΙΟ



BIGSOLAR

Λ. Νάτο 100, 19300 Ασπρόπυργος

Τηλ: 210 5509090

Fax: 210 5594559

E-mail: info@big solar.gr

Web: www.big solar.gr

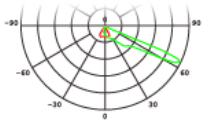

40°x15° Asy

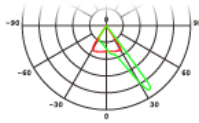

60°x15° Asy

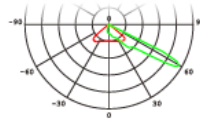

100°x17° Asy

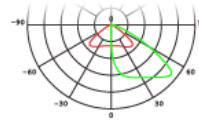

100°x60° Asy

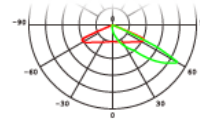

130°x25° Asy

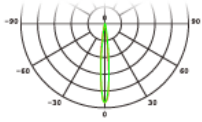

12°

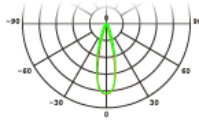

30°

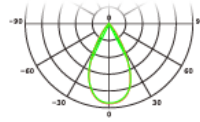

60°



Symmetric



Asymmetric

Installation



Mounting bracket

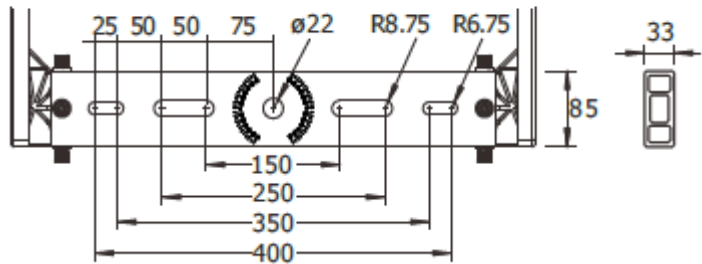

Position allowed



This Modular floodlight can be installed on pole, wall, ceiling or on a horizontal surface.

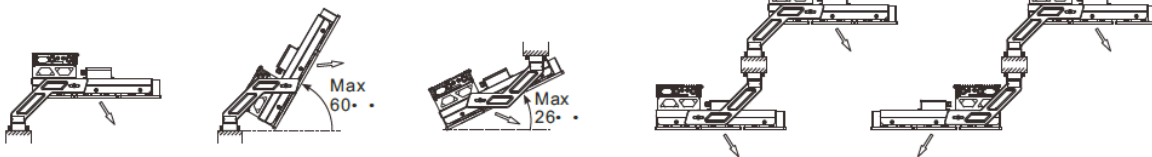

Position not allowed



Note: Considering the heat dissipation, load bearing and dust accumulation, some installation methods are not allowed.

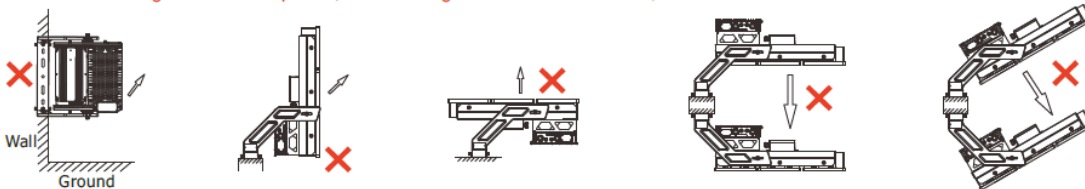

ΦΩΤΙΣΜΟΣ BIGLED



ΦΩΤΟΒΟΛΤΑΪΚΑ



ΨΥΞΗ-ΘΕΡΜΑΝΣΗ



ΒΙΟΜΑΖΑ-ΒΙΟΑΕΡΙΟ



BIGSOLAR

Λ. Νάτο 100, 19300 Ασπρόπυργος
Τηλ: 210 5509090
Fax: 210 5594559
E-mail: info@big solar.gr
Web: www.big solar.gr

Wiring of separated control gear solution



(1) Connection of luminaire

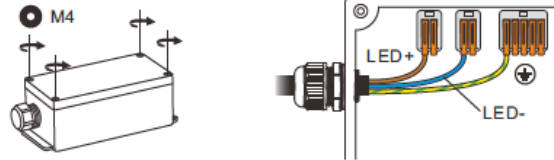

Cable gland of Matrix & Mono

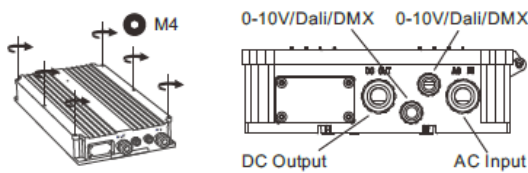

Connection	Cable Gland	Toque (N*m)	Cable Diameter (mm)	Cable Section (mm ²)
AC Input	M20	5.5	8-10/10-12	1.5/2.5
DC Output	M20	5.5	8-10/10-12	1.5/2.5
Dimmable	M16	2.5	7-10	1.0-1.5

(2) Matrix
(0-10V / Dali)

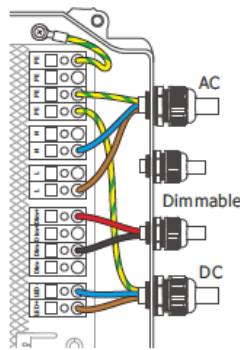

(3) Mono-S
(0-10V / Dali)

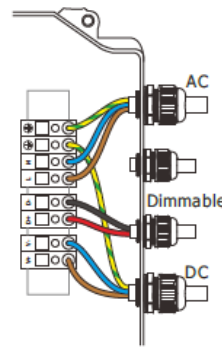

(4) Mono-H
(0-10V / Dali)

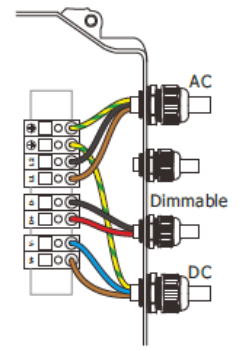

! **Note:** According to the actual needs, the number of connectors will increase or decrease.
 Different dimming function cannot be used at the same time.

Effective Projected Area (EPA=SCx)

Unit: m²



Power	Tilt angle	0°	10°	20°	30°	45°	60°
1000W		0.08	0.09	0.10	0.13	0.15	0.18



ΦΩΤΙΣΜΟΣ BIGLED



ΦΩΤΟΒΟΛΤΑΪΚΑ



ΨΥΞΗ-ΘΕΡΜΑΝΣΗ



ΒΙΟΜΑΖΑ-ΒΙΟΑΕΡΙΟ



BIGSOLAR

Λ. Νάτο 100, 19300 Ασπρόπυργος

Τηλ: 210 5509090

Fax: 210 5594559

E-mail: info@big solar.gr

Web: www.big solar.gr

Application

Suitable for football stadiums, tennis courts, stadiums and other large sports venues, high mast, harbor, airport, warehouse, workshop, gas stations, toll stations, parking area, etc.



ΦΩΤΙΣΜΟΣ BIGLED



ΦΩΤΟΒΟΛΤΑΪΚΑ



ΨΥΞΗ-ΘΕΡΜΑΝΣΗ



ΒΙΟΜΑΖΑ-ΒΙΟΑΕΡΙΟ